



SPECIFICATIONS

- Cylinder:** Extruded aluminum 6063-T5, .090" thick.* See finish note.
- Reflector:** Spun aluminum alloy 3002, electro-chemically processed to provide specular finish.
- Lamp:** Incandescent, up to 150w PAR lamp in up light, up to 250w PAR lamp in down light (by others).
- Lamp Holder:** High heat porcelain medium base, 4 KV rated with nickel plated copper screw shell, spring loaded center contact, lamp grips, SF-2 leads (200° C). Impregnated gasket.
- Canopy Set:** (Pendant Mount) 0-45° hang straight for 3/8" x 12" long steel pipe standard length with P2 accessory. Other lengths available. Finished to match housing.*



- Surface Mount:** Cast Aluminum 5/32" thick EZ5® splice box mounts to standard 4" octagonal junction box. Safety clip supports cylinder for hands free splice connection. Three #10-32 screws set 120° apart for twist and lock-up of cylinder to splice box. Supplied with quick-connect wiring harness. EZ5® design allows the contractor to install the fixture in 5 easy minutes or less. See illustration above. Finished same as housing. See finish note.
- Wall Bracket Assembly:** One-piece cast aluminum bracket /arm assembly with access plate for wire inspection. Cast aluminum, wall mounting plate with 1/4" thick neoprene gasket. Quick disconnect wiring harness. Escos EZ5® Mounting System allows the contractor to install the fixture in 5 minutes or less. Finished same as housing. See finish note.

- Trunion Mount:** 14 Gauge (.074") steel trunion with 180° pivot, adjusting knobs lock fixture into position. Designed for direct mounting to electrical box. See finish note.
- Finish:** Detergent cleaned with iron phosphate and chromic acid rust inhibitor. Chip resistant powder urethane polyester coating, electro-static applied and baked. Standard colors white or bronze. Custom colors are available. Consult factory or sales representative.

- Labels:** Pendant mount suitable for damp location; wall mount suitable for wet location; surface mount suitable for wet location under covered ceiling. ETL, CETL and I.B.E.W. labeled.
- Fixture Warranty:** The fixture mechanics are guaranteed to be free from defective material and workmanship, under normal installation and operating conditions, for **ten years** from date of shipment from the factory. See General Terms and Conditions.
- Photometric Information:** Contact factory.

*Canopy set for indoor applications only; contact factory for other applications and designs.
SPECIFICATIONS SUBJECT TO CHANGE WITHOUT NOTICE



DIMENSIONS

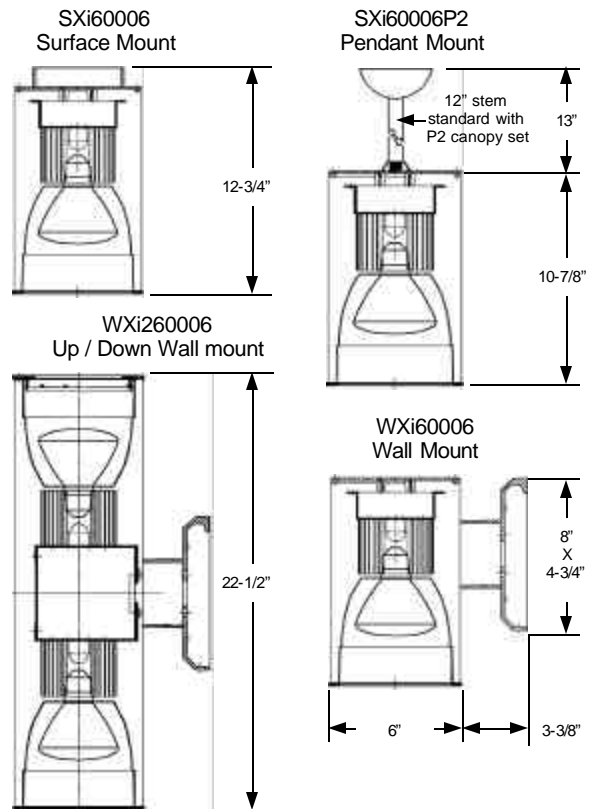

WBE City of Chicago Certified

3254 North Kilbourn Avenue Chicago, Illinois 60641-4505
 Phone: 773-427-7000 Fax: 800-217-1260 www.escolighting.com
Established 1975











HOW TO ORDER

Catalog Number	Mounting System	Maximum Wattage	Lamp Base	Color Suffix Catalog Number With
SXi60006	Surface Mount	250W Maximum incandescent PAR Lamp	Medium	White= W
SXi60006P2	Pendant Mount	250W Maximum incandescent PAR Lamp	Medium	Bronze= BZ
WXi60006	Wall Mount	250W Maximum incandescent PAR Lamp	Medium	Black= BL
WXi260006	Up / Down Wall Mount	150W Up / 250W Down Maximum incandescent PAR Lamp	Medium	

EXAMPLE: SXi61006BLFP224 = 6" diameter cylinder, mini-groove black baffle, fuse and fuse holder, pendant mount with 24" stem, textured black

OPTIONS AND ACCESSORIES

Aperture Accessories	
	Mini-Groove Black Baffle Replace 60 in catalog number with 61 Example: SXi60006 becomes SXi61006
	Louver Guard Suffix catalog number with LG1 Example: SXi60006 becomes SXi60006LG1
Mounting Options	
	Trunion mount Change S in catalog number to T Example: SXi60006 becomes TXi60006
	Pendant Mount Suffix P2=12" long stem (standard) P2X="X" is custom stem length Example: P224= 24" long stem
	EZ5® Wall Mount Change Prefix SX to WX Example: SXi60006 becomes WXi60006
Other	
	Photo Control Suffix Catalog number with 120 Volt = PC4 208-277 Volt = PC5 Example: SXi60006 becomes : SXi60006 PC5
	Fuse and Fuse Holder Suffix Catalog Number With F Example: : SXi60006 becomes : SXi60006 F



WBE City of Chicago Certified

3254 North Kilbourn Avenue Chicago, Illinois 60641-4505
 Phone: 773-427-7000 Fax: 800-217-1260 www.escolighting.com
 Established 1975

